

FINITURE LAVABO E BACINELLE / WASHBASIN AND BOWLS FINISHES



Essential colors

- Bianco / white glossy
- Nero / black glossy
- Fumo - glossy
- Talpa - glossy

Le Terre di Cielo

- Talco
- Pomice
- Brina
- Basalto
- Lavagna
- Cemento
- Fango
- Cacao
- Arenaria
- Avena
- Lino
- Agave
- Muschio
- Polvere
- Cipria
- Canapa

Le Acque di Cielo

- Oltremare
- Smeraldo
- Alga
- Corallo
- Ninfea
- Anemone

FINITURE PIANI E MENSOLA / COUNTERTOPS AND SHELF FINISHES

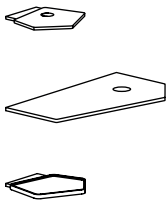

Essential colors

- Bianco / white glossy
- Nero / black glossy
- Fumo - glossy
- Talpa - glossy

Le Terre di Cielo

- Talco
- Pomice
- Brina
- Basalto
- Lavagna
- Cemento
- Fango
- Cacao
- Arenaria
- Avena
- Lino
- Agave
- Muschio
- Polvere
- Cipria
- Canapa

Le Acque di Cielo

- Oltremare
- Smeraldo
- Alga
- Corallo
- Ninfea
- Anemone

FINITURE MOBILE 50 E MOBILE 87 / CABINET 50 AND CABINET 87 FINISHES

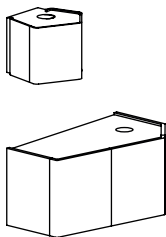

Essential colors

- Fumo - glossy
- Talpa - glossy

Le Terre di Cielo

- Talco
- Pomice
- Brina
- Basalto
- Cemento
- Arenaria
- Avena
- Muschio
- Agave

Le Acque di Cielo

- Oltremare
- Smeraldo
- Alga
- Corallo
- Ninfea
- Anemone

Essenze / wood essences

- Rovere Sbiancato
- Rovere Naturale
- Rovere Nero
- Rovere Tinto Noce
- Eucalipto

ACCESSORI / ACCESSORIES

Pilette / click-clack drains:

PIL01 - Piletta universale click-clack CROMO con coperchio in ceramica
Universal click-clack drain in CHROME with ceramic lid

PIL01NM - Piletta universale click-clack NERO MATT con coperchio in ceramica
Universal click-clack drain in MATT BLACK with ceramic lid

PIL01BR - Piletta universale click-clack BRONZO con coperchio in ceramica
Universal click-clack drain in BRONZE with ceramic lid

PIL01CM - Piletta universale click-clack CEMENTO con coperchio in ceramica
Universal click-clack drain in CEMENTO with ceramic lid

Sifoni / siphons:

SISP - Sifone CROMO
CHROME siphon

SIFN - Sifone NERO MATT
MATT BLACK siphon

SIFBR - Sifone BRONZO
BRONZE siphon

SIFCM - Sifone CEMENTO
CEMENTO siphon

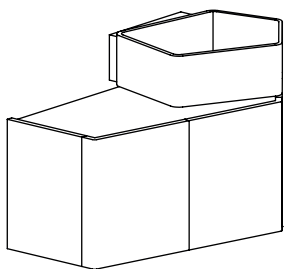

lavabo / washbasin
art. KALS

piano in ceramica / ceramic top
art. KAPI87

mobile 87 / cabinet 87
art. KAM87L / KAM87E

NOTE/NOTES

Disponibile nell'opzione senza foro rubinetto (piano art. KALSSF) - con troppopieno (art. KALSTR) - senza foro, con troppopieno (art. KALSTRSF)
Available the option without tap hole (countertop art. KALSSF) - with overflow (art. KALSTR) - without tap hole, with overflow (art. KALSTRSF)

Marzo 2025

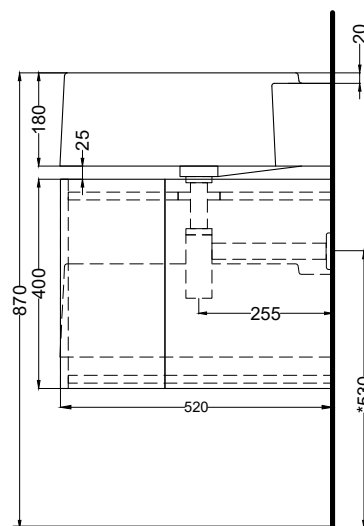
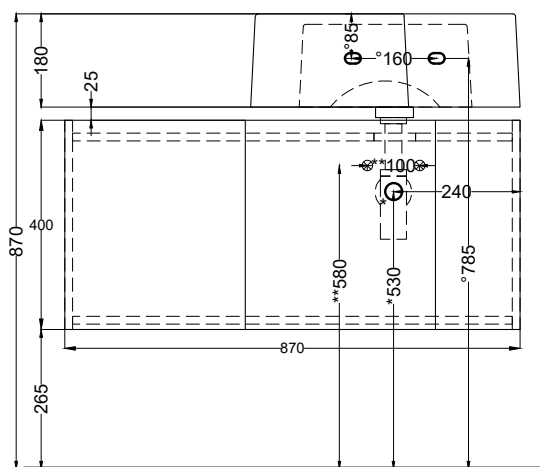
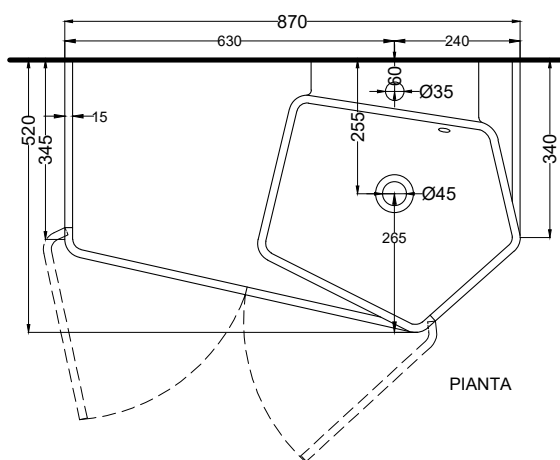

* = water outlet (with standard siphon)
** = water inlet (hot/cold)
° = fixings

ATTENZIONE:
Superfici, pesi e misure riportate possono presentare leggere differenze rispetto ai pezzi reali, in considerazione e accordo delle caratteristiche di tolleranza intrinseche del materiale ceramico e del suo processo produttivo. L'azienda si riserva di cambiare schede tecniche e caratteristiche di funzionamento degli articoli in ogni momento e senza necessità di preavviso.

ATTENTION:
Surfaces, weights and dimensions can show some little differences compared to the real item, following typical intrinsic characteristics of ceramics material and production. The company reserves the right to change any technical specifications/ dimension and/or operating characteristics of the products at any time and without giving notice.

Kanto

bacinella Era Small con piano in ceramica e mobile 87

Era Small on top bowl with ceramic top and cabinet 87

cielo

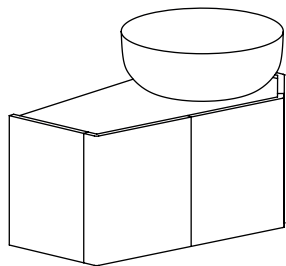

bacinella / on top bowl
art. BAERA40

piano in ceramic / ceramic top
art. KAPI87

mobile 87 / cabinet 87
art. KAM87L / KAM87E

Gennaio 2025

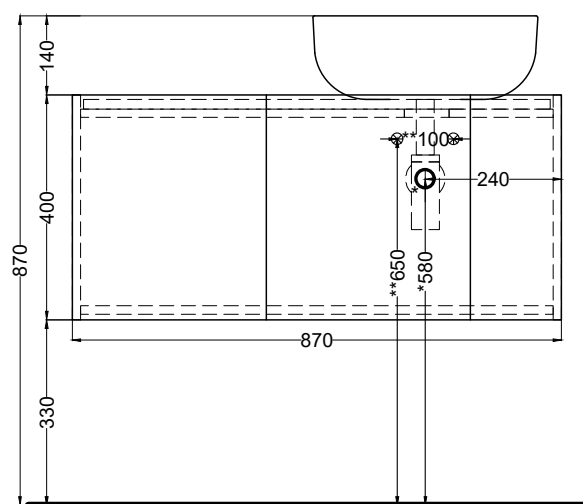
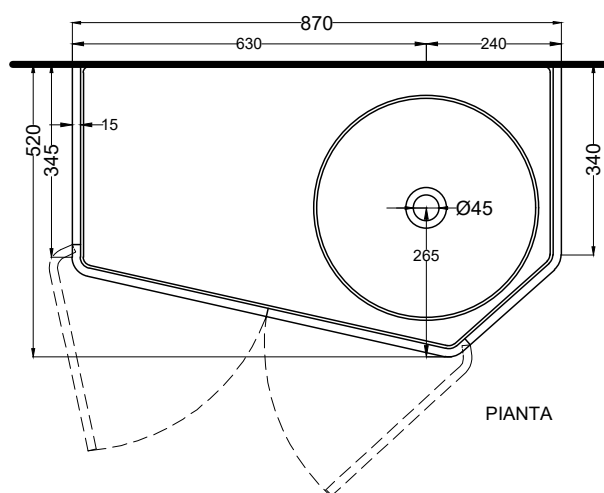

PROSPETTO FRONTALE

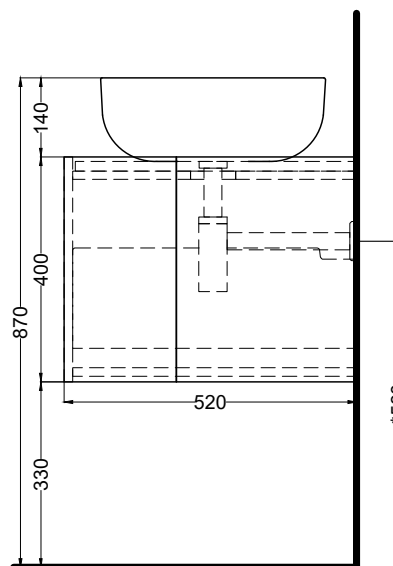

PROSPETTO LATERALE

* = water outlet (with standard siphon)
** = water inlet (hot\cold)
° = fixings

ATTENZIONE:
Superfici, pesi e misure riportate possono presentare leggere differenze rispetto ai pezzi reali, in considerazione e accordo delle caratteristiche di tolleranza intrinseche del materiale ceramico e del suo processo produttivo. L'azienda si riserva di cambiare schede tecniche e caratteristiche di funzionamento degli articoli in ogni momento e senza necessità di preavviso.

ATTENTION:
Surfaces, weights and dimensions can show some little differences compared to the real item, following typical intrinsic characteristics of ceramics material and production. The company reserves the right to change any technical specifications/ dimension and/or operating characteristics of the products at any time and without giving notice.

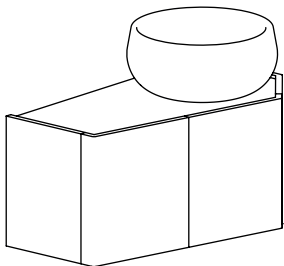

bacinella / on top bowl
art. BATO

piano in ceramica / ceramic top
art. KAPI87

mobile 87 / cabinet 87
art. KAM87L / KAM87E

Gennaio 2025

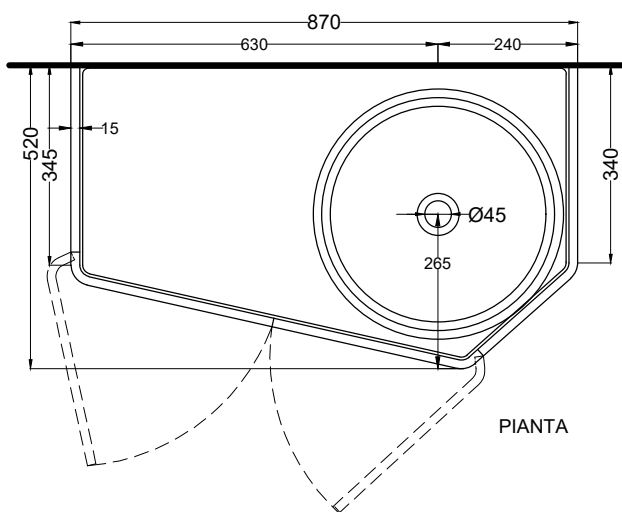

PIANTA

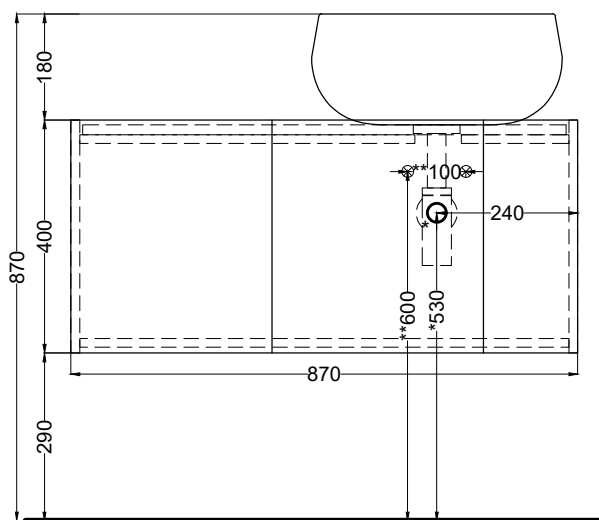

PROSPETTO FRONTALE

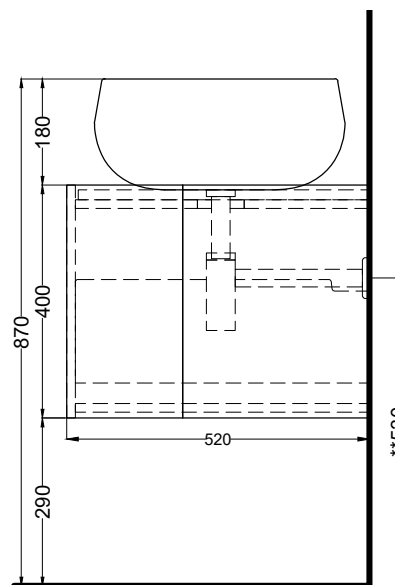

PROSPETTO LATERALE

* = water outlet (with standard siphon)
** = water inlet (hot/cold)
° = fixings

ATTENZIONE:
Superfici, pesi e misure riportate possono presentare leggere differenze rispetto ai pezzi reali, in considerazione e accordo delle caratteristiche di tolleranza intrinseche del materiale ceramico e del suo processo produttivo. L'azienda si riserva di cambiare schede tecniche e caratteristiche di funzionamento degli articoli in ogni momento e senza necessità di preavviso.

ATTENTION:
Surfaces, weights and dimensions can show some little differences compared to the real item, following typical intrinsic characteristics of ceramics material and production. The company reserves the right to change any technical specifications/ dimension and/or operating characteristics of the products at any time and without giving notice.

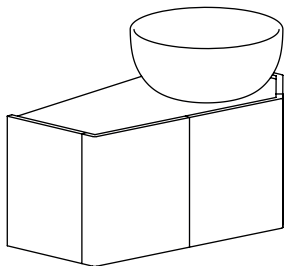

bacinella / on top bowl
art. SHBA40

piano in ceramica / ceramic top
art. KAPI87

mobile 87 / cabinet 87
art. KAM87L / KAM87E

Gennaio 2025

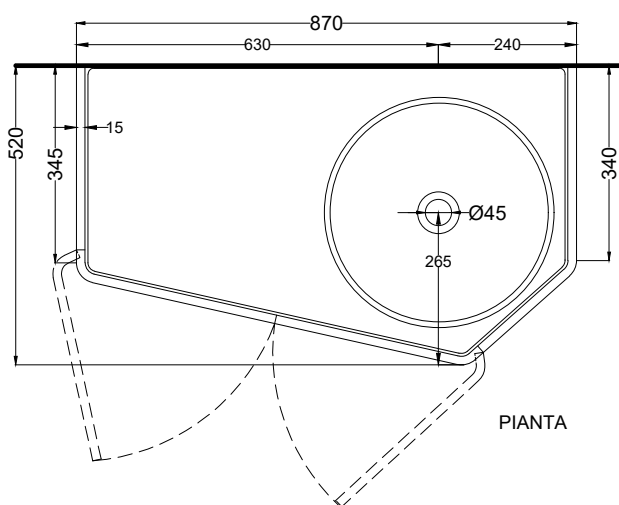

PIANTA

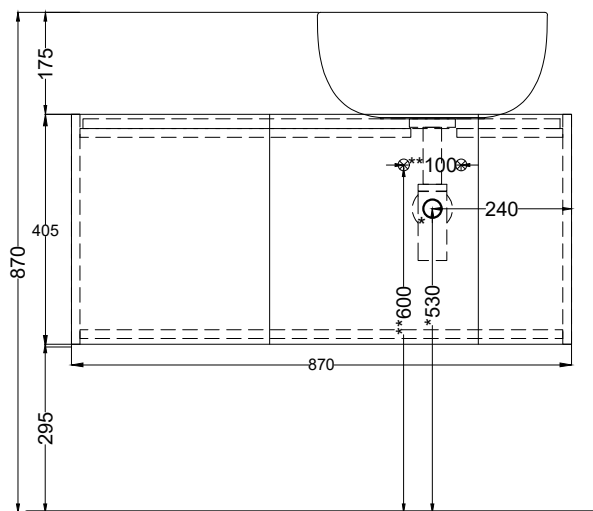

PROSPETTO FRONTALE

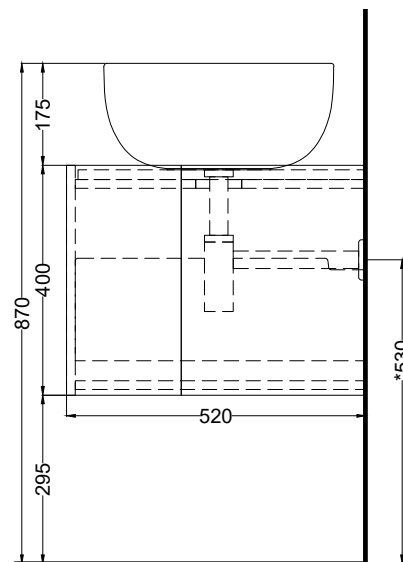

PROSPETTO LATERALE

* = water outlet (with standard siphon)
** = water inlet (hot/cold)
° = fixings

ATTENZIONE:
Superfici, pesi e misure riportate possono presentare leggere differenze rispetto ai pezzi reali, in considerazione e accordo delle caratteristiche di tolleranza intrinseche del materiale ceramico e del suo processo produttivo. L'azienda si riserva di cambiare schede tecniche e caratteristiche di funzionamento degli articoli in ogni momento e senza necessità di preavviso.

ATTENTION:
Surfaces, weights and dimensions can show some little differences compared to the real item, following typical intrinsic characteristics of ceramics material and production. The company reserves the right to change any technical specifications/ dimension and/or operating characteristics of the products at any time and without giving notice.