

Theo 175 art. THMF175A4/THMF175A4SF/THPL/THGA

Mobile Theo 175 con 4 ante e un vano giorno in Fenix
 Theo 175 with 4 doors and an open compartment

cielo
 handmade in Italy



PESO NETTO/NET WEIGHT: 10,50 Kg (lavabo/washbasin) + 53,00 Kg (mobile/cabinet) + 0,35 Kg (portasciugamani/towel rail) + 1,50 Kg (gamba in metallo/metal leg)

ACCESSORI/ACCESSORIES:

PIL01 - Piletta universale click-clack CROMO con coperchio in ceramica / *Universal click-clack drain in CHROME with ceramic lid*
PIL01NM - Piletta universale click-clack NERO MATT con coperchio in ceramica / *Universal click-clack drain in MATT BLACK with ceramic lid*
PIL01BR - Piletta universale click-clack BRONZO con coperchio in ceramica / *Universal click-clack drain in BRONZE with ceramic lid*
PIL01CM - Piletta universale click-clack CEMENTO con coperchio in ceramica / *Universal click-clack drain in CEMENTO with ceramic lid*

SISP - Sifone CROMO / *CHROME siphon*
SIFN - Sifone NERO MATT / *MATT BLACK siphon*
SIFBR - Sifone BRONZO / *BRONZE siphon*
SIFCM - Sifone CEMENTO / *CEMENTO siphon*

FINITURE LAVABO

WASHBASIN

● Bianco/white - glossy

Le Terre di Cielo

- | | |
|-----------|------------|
| ● Talco | ● Arenaria |
| ● Pomice | ● Avena |
| ● Brina | ● Lino |
| ● Basalto | ● Agave |
| ● Lavagna | ● Muschio |
| ● Cemento | ● Polvere |
| ● Fango | ● Cipria |
| ● Cacao | ● Canapa |

Le Acque di Cielo

- | | |
|-------------|-----------|
| ● Oltremare | ● Corallo |
| ● Smeraldo | ● Ninfea |
| ● Alga | ● Anemone |

FINITURE MOBILE IN FENIX

FENIX CABINET FINISHES

- Grafite
- Titanio
- Juta
- Cotone
- Zolfo
- Felce
- Carminio
- Cobalto

FINITURE PORTASCIUGAMANI E GAMBA

TOWEL RAIL FINISHES AND METAL LEG

- Nero Matt - Matt Black
- Cemento

Le Acque di Cielo

- | | |
|-------------|-----------|
| ● Oltremare | ● Corallo |
| ● Smeraldo | ● Ninfea |
| ● Alga | ● Anemone |



DoP No. 14688.01

Giugno 2023

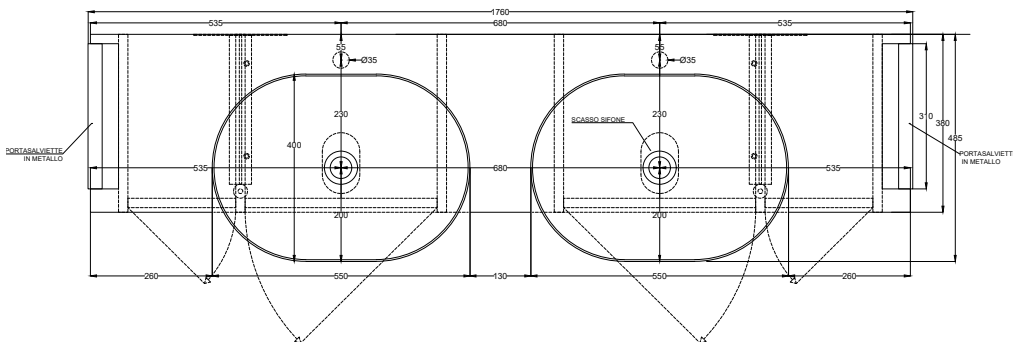
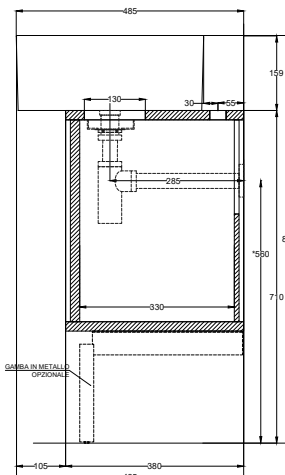
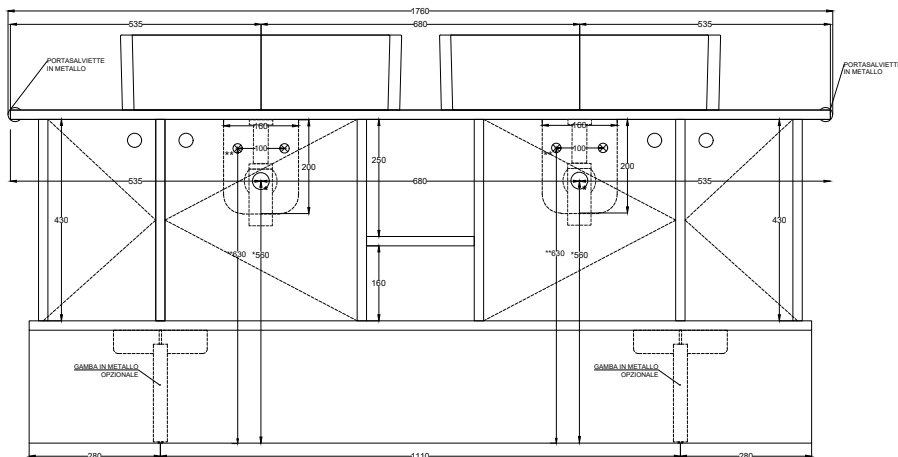

ATTENZIONE:
 Superfici, pesi e misure riportate possono presentare leggere differenze rispetto ai pezzi reali, in considerazione e accordo delle caratteristiche di tolleranza intrinseche del materiale ceramico e del suo processo produttivo. L'azienda si riserva di cambiare schede tecniche e caratteristiche di funzionamento degli articoli in ogni momento e senza necessità di preavviso.

ATTENTION:
 Surfaces, weights and dimensions can show some little differences compared to the real item, following typical intrinsic characteristics of ceramics material and production. The company reserves the right to change any technical specifications/dimension and/or operating characteristics of the products at any time and without giving notice.